

一、BZS-C452404 系统服务器升级 CPU 操作方法：

- 1、准备配件：散热片、CPU
- 2、打开 CPU 固定杆

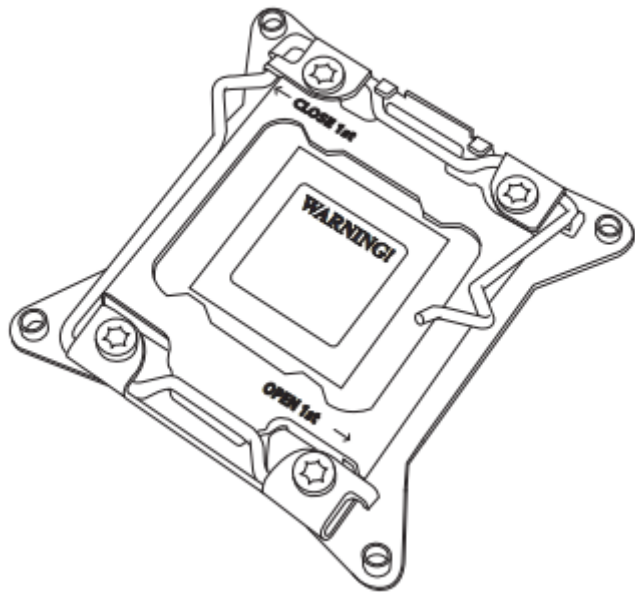

注意：首先打开标有 OPEN 1ST 杆，然后再打开 CLOSE 1ST.杆

- 3、打开 CPU 底座上盖

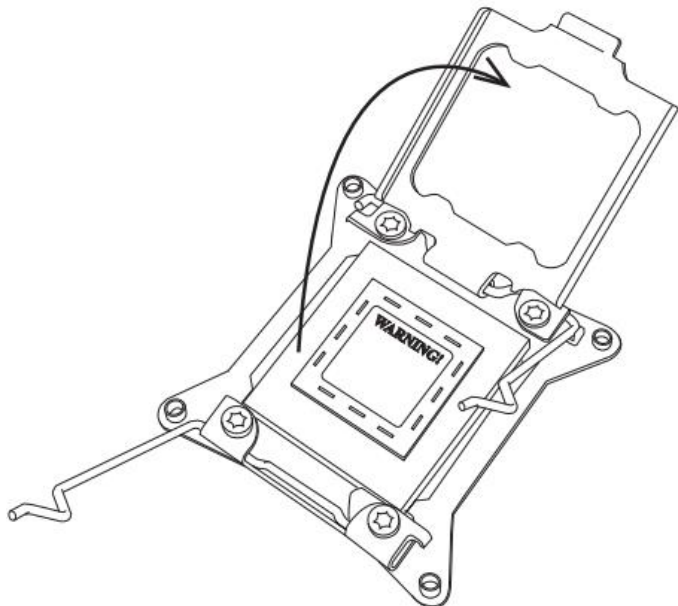

- 4、安装 CPU

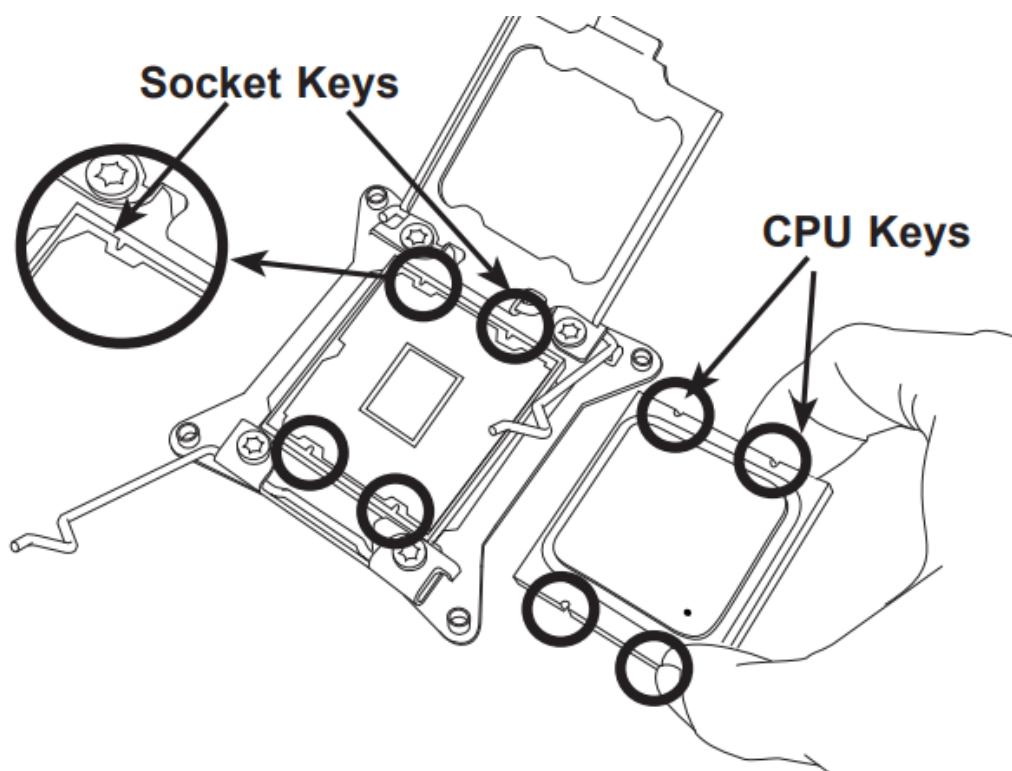

注意：CPU 上的豁口与 CPU 底座要一致。

5、关闭 CPU 底座上盖。

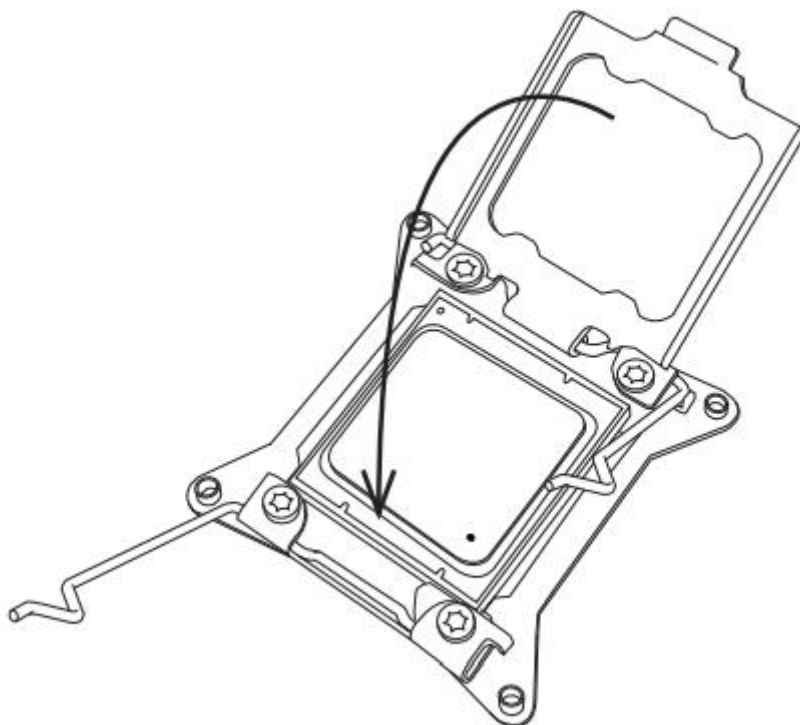

6、首先关闭 CLOSE 1ST 杆，然后再关闭 OPEN 1ST 杆。

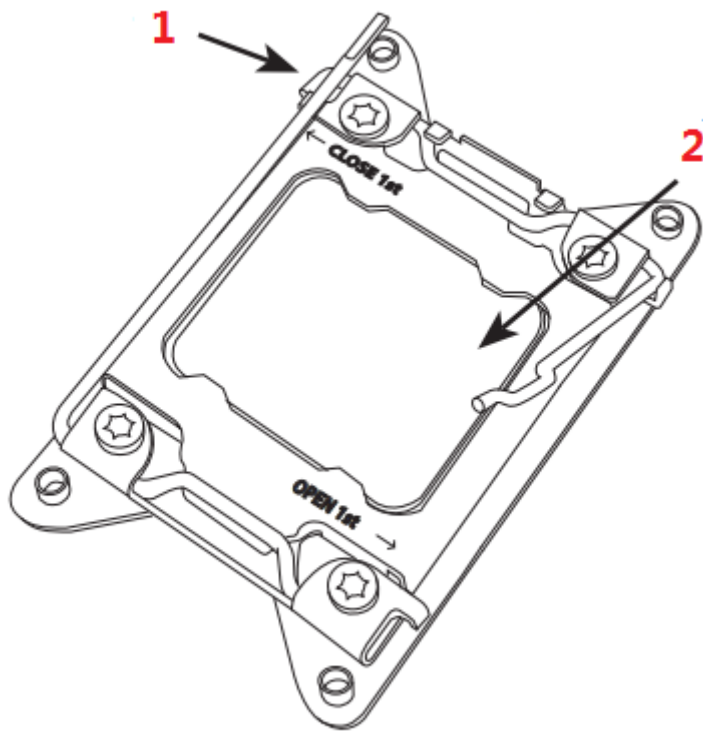

7、安装散热片。

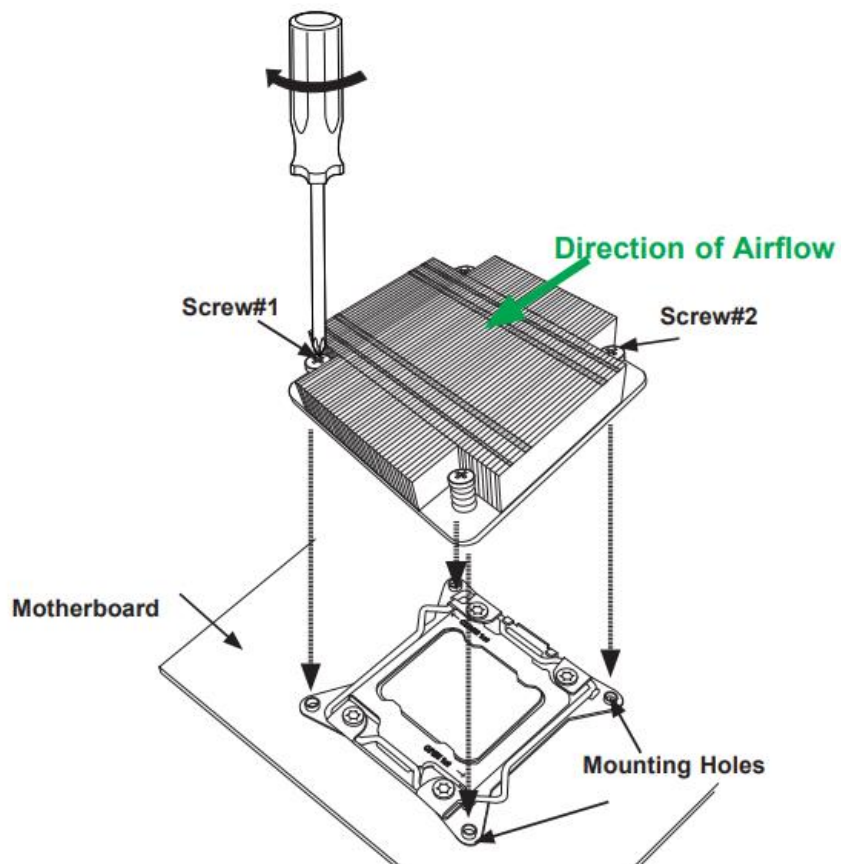

二、BZS-C452404 系统服务器升级内存操作方法：

1、安装时注意内存豁口与防呆口位置对应，打开内存固定卡扣，放入内存垂直按下，直到内存固定卡扣自动锁定。

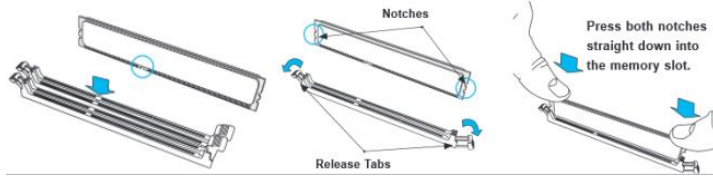

2、只升级 CPU1 的内存操作方法：

1CPU & 1DIMM	P1-DIMM A0							
1CPU & 2DIMM	P1-DIMM A0	P1-DIMM B0						
1CPU & 3DIMM	P1-DIMM A0	P1-DIMM B0	P1-DIMM C0					
1CPU & 4DIMM	P1-DIMM A0	P1-DIMM B0	P1-DIMM C0	P1-DIMM D0				
1CPU & 5DIMM	P1-DIMM A0	P1-DIMM B0	P1-DIMM C0	P1-DIMM D0	P1-DIMM E0			
1CPU & 6DIMM	P1-DIMM A0	P1-DIMM B0	P1-DIMM C0	P1-DIMM D0	P1-DIMM E0	P1-DIMM F0		
1CPU & 7DIMM	P1-DIMM A0	P1-DIMM B0	P1-DIMM C0	P1-DIMM D0	P1-DIMM E0	P1-DIMM F0	P1-DIMM A1	
1CPU & 8DIMM	P1-DIMM A0	P1-DIMM B0	P1-DIMM C0	P1-DIMM D0	P1-DIMM E0	P1-DIMM F0	P1-DIMM A1	P1-DIMM B1

此表每行代表一条内存，只升级 CPU1 的内存请按此表对应主板 DIMM 槽标法安装。

3、升级 CPU2 的内存操作方法：

2CPU & 2DIMM	P1-DIMM A0							
	P2-DIMM A0							
2CPU & 4DIMM	P1-DIMM A0	P1-DIMM B0						
	P2-DIMM A0	P2-DIMM B0						
2CPU & 6DIMM	P1-DIMM A0	P1-DIMM B0	P1-DIMM C0					
	P2-DIMM A0	P2-DIMM B0	P2-DIMM C0					
2CPU & 8DIMM	P1-DIMM A0	P1-DIMM B0	P1-DIMM C0	P1-DIMM D0				
	P2-DIMM A0	P2-DIMM B0	P2-DIMM C0	P2-DIMM D0				
2CPU & 10DIMM	P1-DIMM A0	P1-DIMM B0	P1-DIMM C0	P1-DIMM D0	P1-DIMM E0			
	P2-DIMM A0	P2-DIMM B0	P2-DIMM C0	P2-DIMM D0	P2-DIMM E0			
2CPU & 12DIMM	P1-DIMM A0	P1-DIMM B0	P1-DIMM C0	P1-DIMM D0	P1-DIMM E0	P1-DIMM F0		
	P2-DIMM A0	P2-DIMM B0	P2-DIMM C0	P2-DIMM D0	P2-DIMM E0	P2-DIMM F0		
2CPU & 14DIMM	P1-DIMM A0	P1-DIMM B0	P1-DIMM C0	P1-DIMM D0	P1-DIMM E0	P1-DIMM F0	P1-DIMM A1	
	P2-DIMM A0	P2-DIMM B0	P2-DIMM C0	P2-DIMM D0	P2-DIMM E0	P2-DIMM F0	P2-DIMM A1	
2CPU & 16DIMM	P1-DIMM A0	P1-DIMM B0	P1-DIMM C0	P1-DIMM D0	P1-DIMM E0	P1-DIMM F0	P1-DIMM A1	P1-DIMM B1
	P2-DIMM A0	P2-DIMM B0	P2-DIMM C0	P2-DIMM D0	P2-DIMM E0	P2-DIMM F0	P2-DIMM A1	P2-DIMM B1

同 CPU1 一样，每行上面是 CPU1 内存对应插法，下面是 CPU2 内存对应插法。

三、BZS-C452404 系统服务器升级硬盘操作方法：

1、硬盘排序如下图：

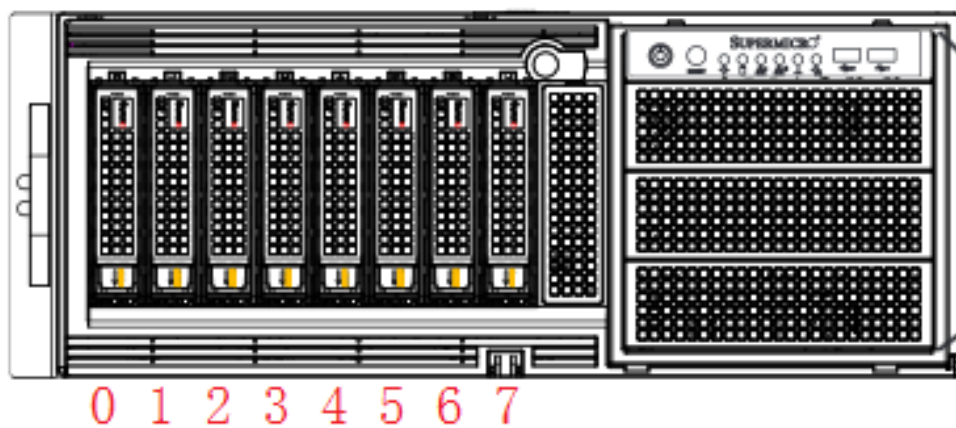

2、按下卡扣，弹出硬盘盒拉手，取出硬盘盒。

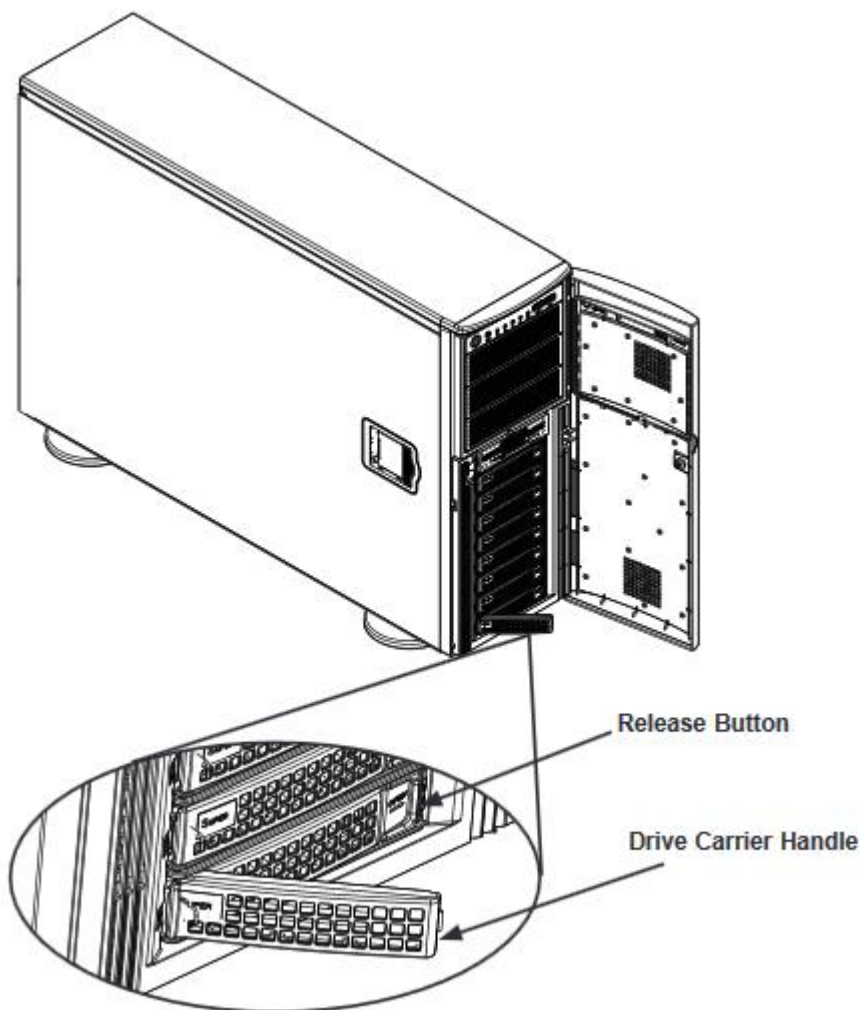

3、安装硬盘。

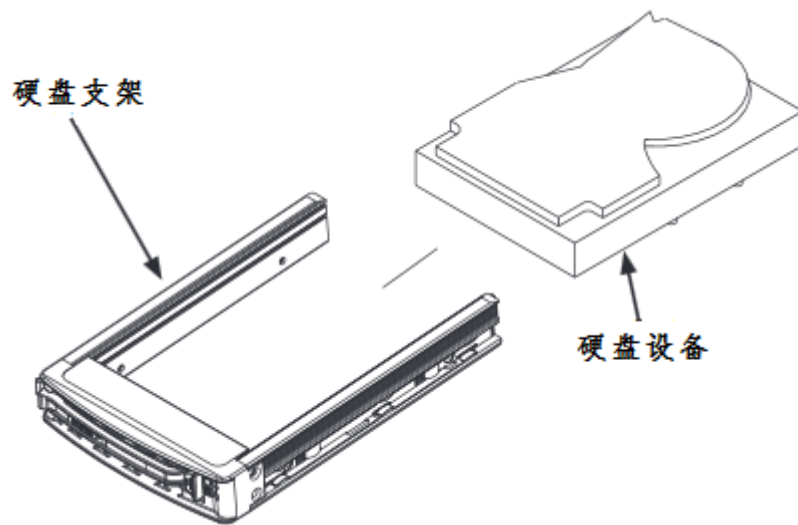

4、二侧各用 2 颗 3.5 寸平头螺丝固定硬盘。

